

# 6-Pin DIP General Purpose Photodarlington Optocoupler

## 4N29M, 4N30M, 4N32M, 4N33M, H11B1M, TIL113M

### Description

The 4N29M, 4N30M, 4N32M, 4N33M, H11B1M, and TIL113M have a gallium arsenide infrared emitter optically coupled to a silicon planar photodarlington.

### Features

- High Sensitivity to Low Input Drive Current
- Meets or Exceeds All JEDEC Registered Specifications
- Safety and Regulatory Approvals:
  - ◆ UL1577, 4,170 VAC<sub>RMS</sub> for 1 Minute
  - ◆ DIN-EN/IEC60747-5-5, 850 V Peak Working Insulation Voltage

### Applications

- Low Power Logic Circuits
- Telecommunications Equipment
- Portable Electronics
- Solid State Relays
- Interfacing Coupling Systems of Different Potentials and Impedances

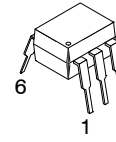

PDIP6  
CASE 646BX

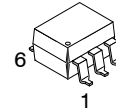

PDIP6  
S SUFFIX  
CASE 646BY

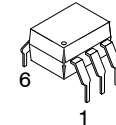

PDIP6  
T SUFFIX  
CASE 646BZ

### MARKING DIAGRAM

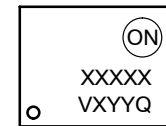

- ON = Logo
- XXXXX = Specific Device Code
- V = DIN EN/IEC60747-5-5 Option (only appears on component ordered with this option)
- X = One-Digit Year Code
- YY = Digit Work Week
- Q = Assembly Package Code

### SCHEMATIC

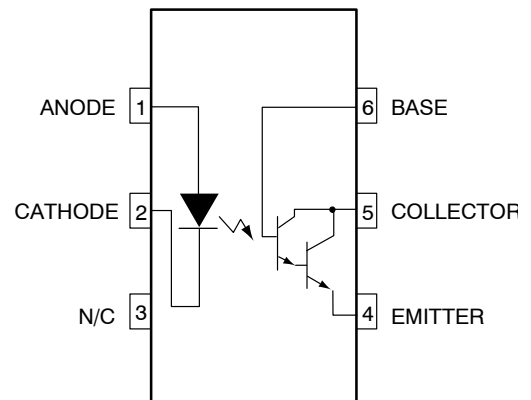

### ORDERING INFORMATION

See detailed ordering and shipping information on page 8 of this data sheet.

## 4N29M, 4N30M, 4N32M, 4N33M, H11B1M, TIL113M

**SAFETY AND INSULATION RATINGS** (As per DIN EN/IEC 60747-5-5, this optocoupler is suitable for “safe electrical insulation” only within the safety limit data. Compliance with the safety ratings shall be ensured by means of protective circuits.)

Parameter		Characteristics
Installation Classifications per DIN VDE 0110/1.89 Table 1, For Rated Mains Voltage	< 150 V <sub>RMS</sub>	I-IV
	< 300 V <sub>RMS</sub>	I-IV
Climatic Classification		55/100/21
Pollution Degree (DIN VDE 0110/1.89)		2
Comparative Tracking Index		175

Symbol	Parameter	Value	Unit
V <sub>PR</sub>	Input-to-Output Test Voltage, Method A, V <sub>IORM</sub> × 1.6 = V <sub>PR</sub> , Type and Sample Test with t <sub>m</sub> = 10 s, Partial Discharge < 5 pC	1360	V <sub>peak</sub>
	Input-to-Output Test Voltage, Method B, V <sub>IORM</sub> × 1.875 = V <sub>PR</sub> , 100% Production Test with t <sub>m</sub> = 1 s, Partial Discharge < 5 pC	1594	V <sub>peak</sub>
V <sub>IORM</sub>	Maximum Working Insulation Voltage	850	V <sub>peak</sub>
V <sub>IOTM</sub>	Highest Allowable Over-Voltage	6000	V <sub>peak</sub>
	External Creepage	≥7	mm
	External Clearance	≥7	mm
	External Clearance (for Option TV, 0.4" Lead Spacing)	≥10	mm
DTI	Distance Through Insulation (Insulation Thickness)	≥0.5	mm
T <sub>S</sub>	Case Temperature (Note 1)	175	°C
I <sub>S,INPUT</sub>	Input Current (Note 1)	350	mA
P <sub>S,OUTPUT</sub>	Output Power (Note 1)	800	mW
R <sub>IO</sub>	Insulation Resistance at T <sub>S</sub> , V <sub>IO</sub> = 500 V (Note 1)	>10 <sup>9</sup>	Ω

1. Safety limit values – maximum values allowed in the event of a failure.

# 4N29M, 4N30M, 4N32M, 4N33M, H11B1M, TIL113M

## ABSOLUTE MAXIMUM RATINGS

Symbol	Parameter	Value	Unit
<b>TOTAL DEVICE</b>			
T <sub>STG</sub>	Storage Temperature	-40 to +125	°C
T <sub>OPR</sub>	Operating Temperature	-40 to +100	°C
T <sub>J</sub>	Junction Temperature	-40 to +125	°C
T <sub>SOL</sub>	Lead Solder Temperature	260 for 10 seconds	°C
P <sub>D</sub>	Total Device Power Dissipation @ T <sub>A</sub> = 25°C	270	mW
	Derate Above 25°C	3.3	mW/°C

## EMITTER

I <sub>F</sub>	Continuous Forward Current	80	mA
V <sub>R</sub>	Reverse Voltage	3	V
I <sub>F(pk)</sub>	Forward Current – Peak (300 μs, 2% Duty Cycle)	3.0	A
P <sub>D</sub>	LED Power Dissipation @ T <sub>A</sub> = 25°C	120	mW
	Derate Above 25°C	2.0	mW/°C

## DETECTOR

BV <sub>CEO</sub>	Collector–Emitter Breakdown Voltage	30	V
BV <sub>CBO</sub>	Collector–Base Breakdown Voltage	30	V
BV <sub>ECO</sub>	Emitter–Collector Breakdown Voltage	5	V
P <sub>D</sub>	Detector Power Dissipation @ T <sub>A</sub> = 25°C	150	mW
	Derate Above 25°C	2.0	mW/°C
I <sub>C</sub>	Continuous Collector Current	150	mA

Stresses exceeding those listed in the Maximum Ratings table may damage the device. If any of these limits are exceeded, device functionality should not be assumed, damage may occur and reliability may be affected.

## ELECTRICAL CHARACTERISTICS – INDIVIDUAL COMPONENT CHARACTERISTICS

(T<sub>A</sub> = 25°C unless otherwise noted)

Symbol	Parameter	Test Conditions	Device	Min	Typ	Max	Unit
V <sub>F</sub>	Input Forward Voltage (Note 2)	I <sub>F</sub> = 10 mA	4NXXM	–	1.2	1.5	V
			H11B1M, TIL113M	0.8	1.2	1.5	V
I <sub>R</sub>	Reverse Leakage Current (Note 2)	V <sub>R</sub> = 3.0 V	4NXXM	–	0.001	100	μA
		V <sub>R</sub> = 6.0 V	H11B1M, TIL113M	–	0.001	10	μA
C	Capacitance (Note 2)	V <sub>F</sub> = 0 V, f = 1.0 MHz	All	–	150	–	pF

## DETECTOR

BV <sub>CEO</sub>	Collector–Emitter Breakdown Voltage (Note 2)	I <sub>C</sub> = 1.0 mA, I <sub>B</sub> = 0	4NXXM, TIL113M	30	60	–	V
			H11B1M	25	60	–	V
BV <sub>CBO</sub>	Collector–Base Breakdown Voltage (Note 2)	I <sub>C</sub> = 100 μA, I <sub>E</sub> = 0	All	30	100	–	V
BV <sub>ECO</sub>	Emitter–Collector Breakdown Voltage (Note 2)	I <sub>E</sub> = 100 μA, I <sub>B</sub> = 0	4NXXM	5.0	10	–	V
			H11B1M, TIL113M	7	10	–	V
I <sub>CEO</sub>	Collector–Emitter Dark Current (Note 2)	V <sub>CE</sub> = 10 V, Base Open	All	–	1	100	nA

Product parametric performance is indicated in the Electrical Characteristics for the listed test conditions, unless otherwise noted. Product performance may not be indicated by the Electrical Characteristics if operated under different conditions.

2. Indicates JEDEC registered data.

## 4N29M, 4N30M, 4N32M, 4N33M, H11B1M, TIL113M

### ELECTRICAL CHARACTERISTICS – TRANSFER CHARACTERISTICS (T<sub>A</sub> = 25°C unless otherwise noted)

Symbol	Parameter	Test Conditions	Device	Min	Typ	Max	Unit
<b>DC CHARACTERISTICS</b>							
I <sub>C(CTR)</sub>	Collector Output Current (Note 3) (Note 4) (Note 5)	I <sub>F</sub> = 10 mA, V <sub>CE</sub> = 10 V, I <sub>B</sub> = 0	4N32M, 4N33M	50 (500)	–	–	mA (%)
			4N29M, 4N30M	10 (100)	–	–	mA (%)
		I <sub>F</sub> = 1 mA, V <sub>CE</sub> = 5 V	H11B1M	5 (500)	–	–	mA (%)
		I <sub>F</sub> = 10 mA, V <sub>CE</sub> = 1 V	TIL113M	30 (300)	–	–	mA (%)
V <sub>CE (SAT)</sub>	Saturation Voltage (Note 3) (Note 5)	I <sub>F</sub> = 8 mA, I <sub>C</sub> = 2.0 mA	4NXXM	–	–	1.0	V
			TIL113M	–	–	1.25	V
		I <sub>F</sub> = 1 mA, I <sub>C</sub> = 1 mA	H11B1M	–	–	1.0	V

### AC CHARACTERISTIC

t <sub>ON</sub>	Turn-on Time	I <sub>F</sub> = 200 mA, I <sub>C</sub> = 50 mA, V <sub>CC</sub> = 10 V, R <sub>L</sub> = 100 Ω	4NXXM, TIL113M	–	–	5.0	μs
		I <sub>F</sub> = 10 mA, V <sub>CE</sub> = 10 V, R <sub>L</sub> = 100 Ω	H11B1M	–	25	–	μs
t <sub>OFF</sub>	Turn-off Time	I <sub>F</sub> = 200 mA, I <sub>C</sub> = 50 mA, V <sub>CC</sub> = 10 V, R <sub>L</sub> = 100 Ω	4N32M, 4N33M, TIL113M	–	–	100	μs
			4N29M, 4N30M	–	–	40	μs
		I <sub>F</sub> = 10 mA, V <sub>CE</sub> = 10 V, R <sub>L</sub> = 100 Ω	H11B1M	–	18	–	μs
BW	Bandwidth (Note 6) (Note 7)			–	30	–	kHz

Product parametric performance is indicated in the Electrical Characteristics for the listed test conditions, unless otherwise noted. Product performance may not be indicated by the Electrical Characteristics if operated under different conditions.

3. Indicates JEDEC registered data.

4. The current transfer ratio (I<sub>C</sub>/I<sub>F</sub>) is the ratio of the detector collector current to the LED input current.

5. Pulse test: pulse width = 300 μs, duty cycle ≤ 2.0%.

6. I<sub>F</sub> adjusted to I<sub>C</sub> = 2.0 mA and I<sub>C</sub> = 0.7 mA rms.

7. The frequency at which I<sub>C</sub> is 3 dB down from the 1 kHz value.

### ELECTRICAL CHARACTERISTICS – ISOLATION CHARACTERISTICS (T<sub>A</sub> = 25°C unless otherwise noted)

Symbol	Parameter	Test Conditions	Min	Typ	Max	Unit
V <sub>ISO</sub>	Input-Output Isolation Voltage	t = 1 Minute	4170	–	–	VAC <sub>RMS</sub>
C <sub>ISO</sub>	Isolation Capacitance	V <sub>I-O</sub> = 0 V, f = 1 MHz	–	0.2	–	pF
R <sub>ISO</sub>	Isolation Resistance	V <sub>I-O</sub> = ±500 VDC, T <sub>A</sub> = 25°C	10 <sup>11</sup>	–	–	Ω

Product parametric performance is indicated in the Electrical Characteristics for the listed test conditions, unless otherwise noted. Product performance may not be indicated by the Electrical Characteristics if operated under different conditions.

TYPICAL PERFORMANCE CURVES

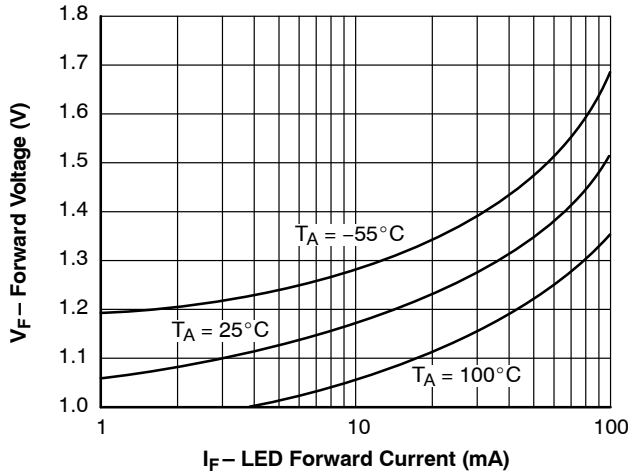

Figure 1. LED Forward Voltage vs. Forward Current

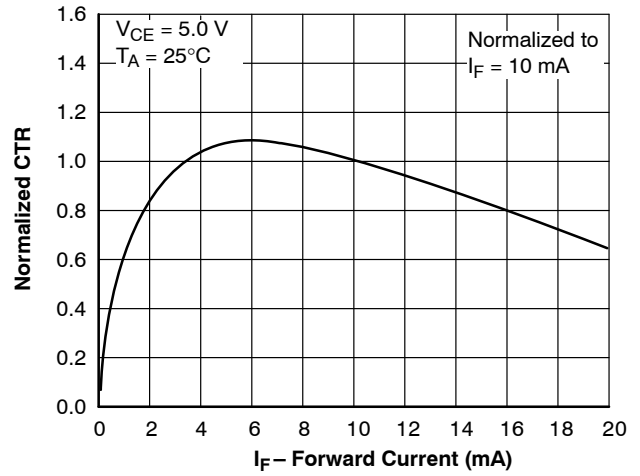

Figure 2. Normalized CTR vs. Forward Current

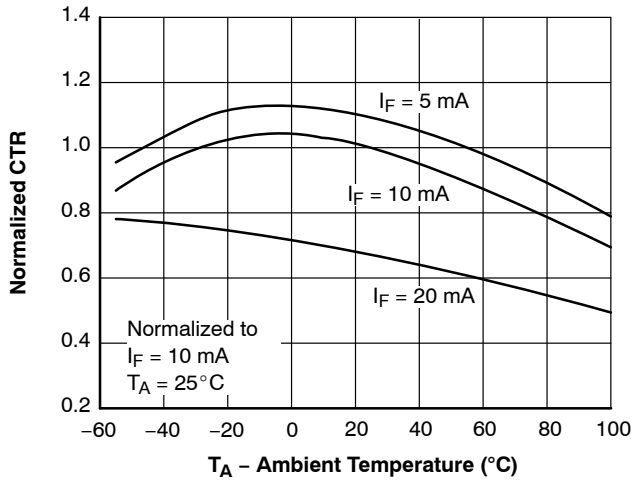

Figure 3. Normalized CTR vs. Ambient Temperature

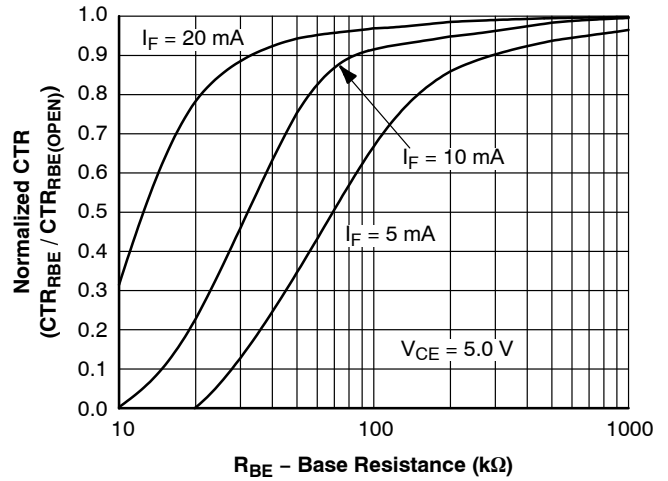

Figure 4. CTR vs. R<sub>BE</sub> (Unsaturated)

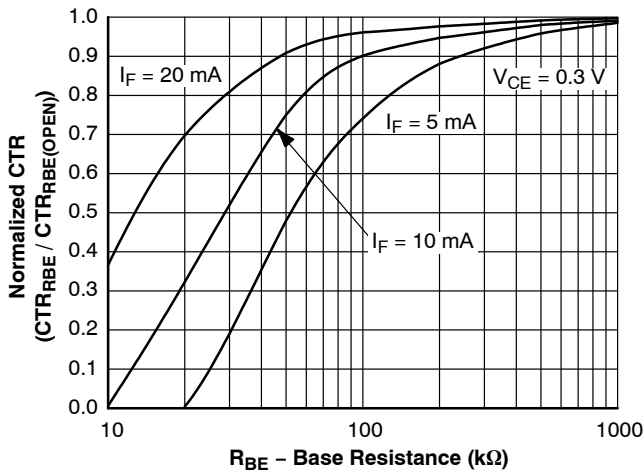

Figure 5. CTR vs. R<sub>BE</sub> (Saturated)

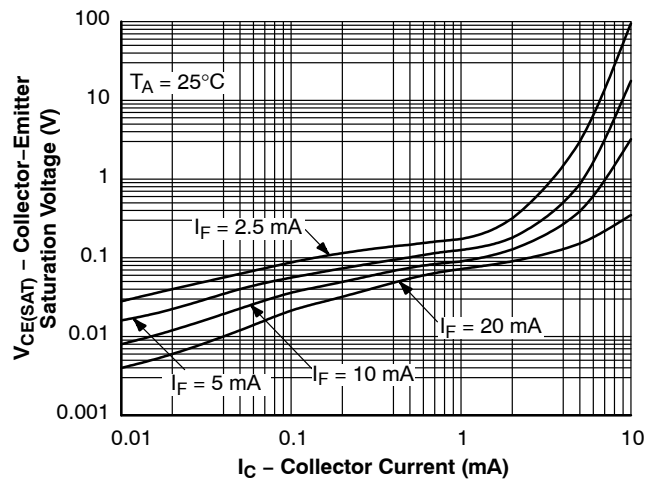

Figure 6. Collector-Emitter Saturation Voltage vs. Collector Current

TYPICAL PERFORMANCE CURVES (continued)

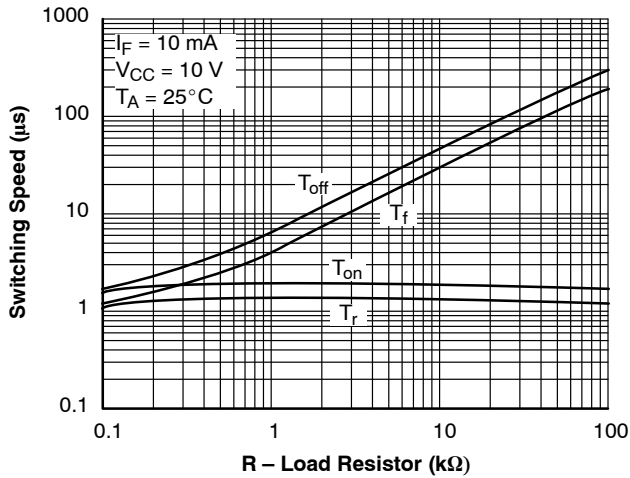

Figure 7. Switching Speed vs. Load Resistor

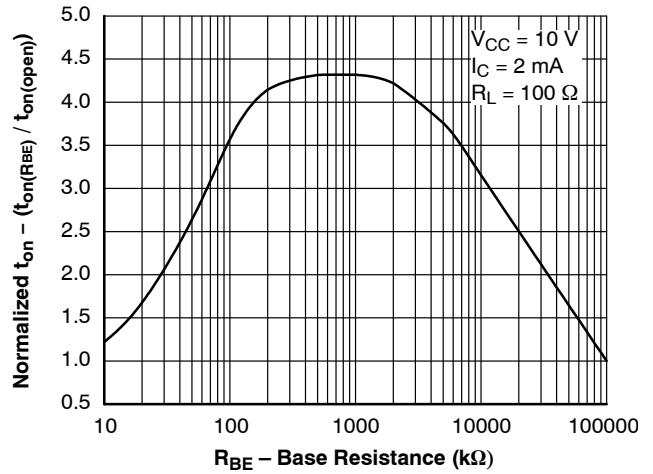

Figure 8. Normalized  $t_{on}$  vs.  $R_{BE}$

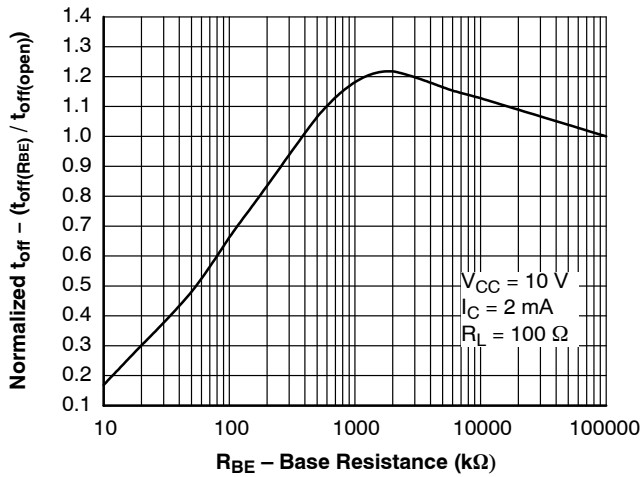

Figure 9. Normalized  $t_{off}$  vs.  $R_{BE}$

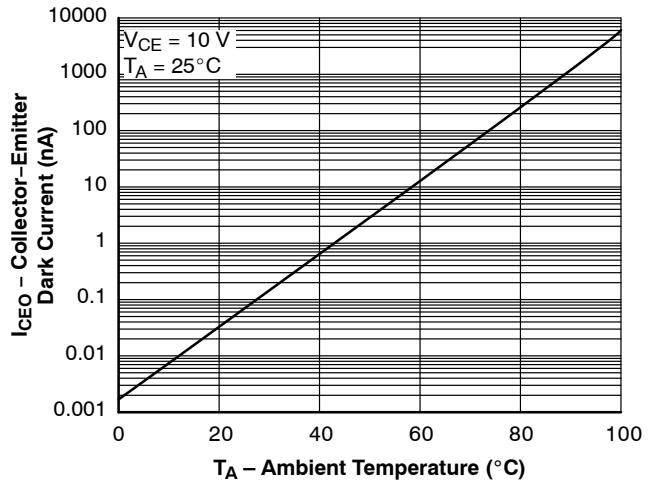

Figure 10. Dark Current vs. Ambient Temperature

SWITCHING TIME TEST CIRCUIT AND WAVEFORMS

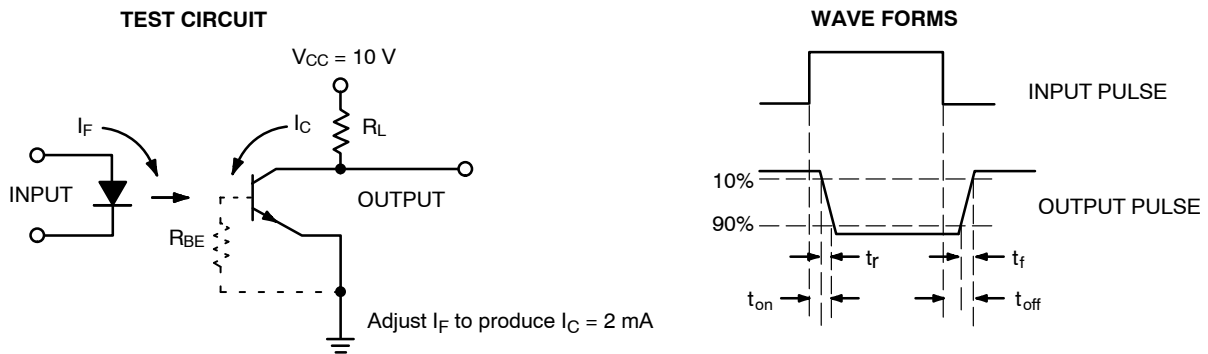

Figure 11. Switching Time Test Circuit and Waveforms

REFLOW PROFILE

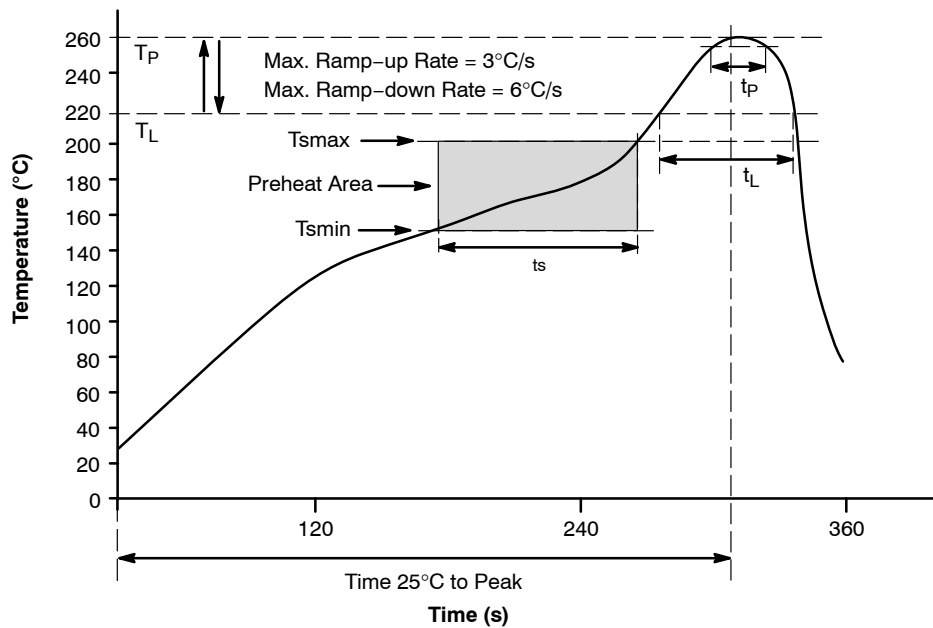

Figure 12. Reflow Profile

REFLOW PROFILE

Profile Feature	Pb-Free Assembly Profile
Temperature Min. (T <sub>smín</sub> )	150°C
Temperature Max. (T <sub>smáx</sub> )	200°C
Time (t <sub>s</sub> ) from (T <sub>smín</sub> to T <sub>smáx</sub> )	60–120 s
Ramp-up Rate (t <sub>L</sub> to t <sub>P</sub> )	3°C/s max.
Liquidous Temperature (T <sub>L</sub> )	217°C
Time (t <sub>L</sub> ) Maintained Above (T <sub>L</sub> )	60–150 s
Peak Body Package Temperature	260°C +0°C / -5°C
Time (t <sub>P</sub> ) within 5°C of 260°C	30 s
Ramp-down Rate (T <sub>P</sub> to T <sub>L</sub> )	6°C/s max.
Time 25°C to Peak Temperature	8 min max.

## 4N29M, 4N30M, 4N32M, 4N33M, H11B1M, TIL113M

### ORDERING INFORMATION

Part Number	Package	Packing Method†
4N29M	DIP 6-Pin	50 Units / Tube
4N29SM	SMT 6-Pin (Lead Bend)	50 Units / Tube
4N29SR2M	SMT 6-Pin (Lead Bend)	1000 / Tape & Reel
4N29VM	DIP 6-Pin, DIN EN/IEC60747-5-5 Option	50 Units / Tube
4N29SVM	SMT 6-Pin (Lead Bend), DIN EN/IEC60747-5-5 Option	50 Units / Tube
4N29SR2VM	SMT 6-Pin (Lead Bend), DIN EN/IEC60747-5-5 Option	1000 / Tape & Reel
4N29TVM	DIP 6-Pin, 0.4" Lead Spacing, DIN EN/IEC60747-5-5 Option	50 Units / Tube

†For information on tape and reel specifications, including part orientation and tape sizes, please refer to our Tape and Reel Packaging Specifications Brochure, BRD8011/D.

8. The product orderable part number system listed in this table also applies to the 4N30M, 4N32M, 4N33M, H11B1M and TIL113M devices.



# MECHANICAL CASE OUTLINE

## PACKAGE DIMENSIONS

ON Semiconductor®



PDIP6 8.51x6.35, 2.54P  
CASE 646BX  
ISSUE O

DATE 31 JUL 2016



NOTES:

- A) NO STANDARD APPLIES TO THIS PACKAGE.
- B) ALL DIMENSIONS ARE IN MILLIMETERS.
- C) DIMENSIONS ARE EXCLUSIVE OF BURRS, MOLD FLASH, AND TIE BAR EXTRUSION

<b>DOCUMENT NUMBER:</b>	<b>98AON13449G</b>	Electronic versions are uncontrolled except when accessed directly from the Document Repository. Printed versions are uncontrolled except when stamped "CONTROLLED COPY" in red.
<b>DESCRIPTION:</b>	<b>PDIP6 8.51X6.35, 2.54P</b>	<b>PAGE 1 OF 1</b>

ON Semiconductor and are trademarks of Semiconductor Components Industries, LLC dba ON Semiconductor or its subsidiaries in the United States and/or other countries. ON Semiconductor reserves the right to make changes without further notice to any products herein. ON Semiconductor makes no warranty, representation or guarantee regarding the suitability of its products for any particular purpose, nor does ON Semiconductor assume any liability arising out of the application or use of any product or circuit, and specifically disclaims any and all liability, including without limitation special, consequential or incidental damages. ON Semiconductor does not convey any license under its patent rights nor the rights of others.

# MECHANICAL CASE OUTLINE

## PACKAGE DIMENSIONS

ON Semiconductor®



### PDIP6 8.51x6.35, 2.54P CASE 646BY ISSUE A

DATE 15 JUL 2019



**NOTES:**

1. DIMENSIONING AND TOLERANCING PER ASME Y14.5M, 2009.
2. CONTROLLING DIMENSION: MILLIMETERS
3. DIMENSIONS A, A1, AND L ARE MEASURED WITH THE PACKAGE SEATED.
4. DIMENSIONS D, D1, AND E1 DO NOT INCLUDE MOLD FLASH OR PROTRUSIONS. MOLD FLASH OR PROTRUSIONS ARE NOT TO EXCEED 2.54mm.
5. PACKAGE CONTOUR IS OPTIONAL (ROUNDED OR SQUARE CORNERS).
6. CENTER LINE OF CORNER LEADS ARE LOCATED BY LOCATING THE CENTER OF FEATURE b2 AND b3.

DIM	MILLIMETERS		
	MIN.	NOM.	MAX.
A	---	---	4.80
A1	0.38	---	---
A2	3.28	3.40	3.53
A3	2.49 REF		
A4	1.89 REF		
b	0.41	0.46	0.51
b1	0.76	0.92	1.14
b2	0.25	0.28	0.36
b3	1.02	1.40	1.78
b4	1.778 REF		
c	0.20	0.25	0.30
D	8.13	8.51	8.89
D1	0.86 REF		
E	6.10	6.35	6.60
E1	8.43	9.17	9.90
E2	8.13 REF		
e	2.54 BSC		
L	0.16	0.52	0.88

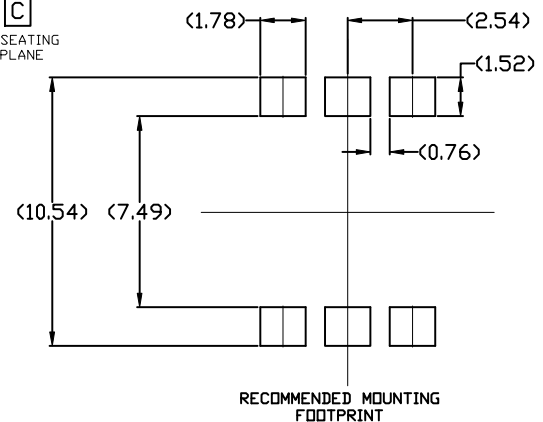
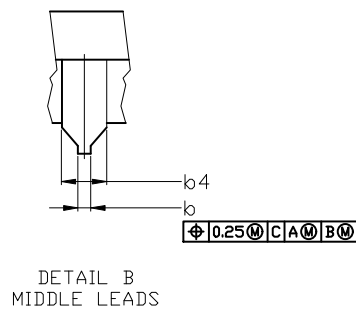
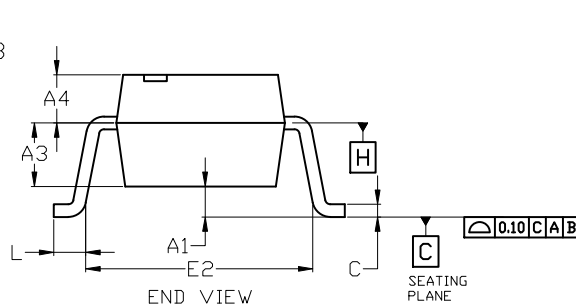

For additional information on our Pb-Free strategy and soldering details, please download the ON Semiconductor Soldering and Mounting Techniques Reference Manual, SOLDERM/D.

<b>DOCUMENT NUMBER:</b>	<b>98AON13450G</b>	Electronic versions are uncontrolled except when accessed directly from the Document Repository. Printed versions are uncontrolled except when stamped "CONTROLLED COPY" in red.
<b>DESCRIPTION:</b>	<b>PDIP6 8.51x6.35, 2.54P</b>	<b>PAGE 1 OF 1</b>

ON Semiconductor and ON are trademarks of Semiconductor Components Industries, LLC dba ON Semiconductor or its subsidiaries in the United States and/or other countries. ON Semiconductor reserves the right to make changes without further notice to any products herein. ON Semiconductor makes no warranty, representation or guarantee regarding the suitability of its products for any particular purpose, nor does ON Semiconductor assume any liability arising out of the application or use of any product or circuit, and specifically disclaims any and all liability, including without limitation special, consequential or incidental damages. ON Semiconductor does not convey any license under its patent rights nor the rights of others.

**MECHANICAL CASE OUTLINE**  
**PACKAGE DIMENSIONS**

ON Semiconductor®



**PDIP6 8.51x6.35, 2.54P**  
CASE 646BZ  
ISSUE O

DATE 31 JUL 2016

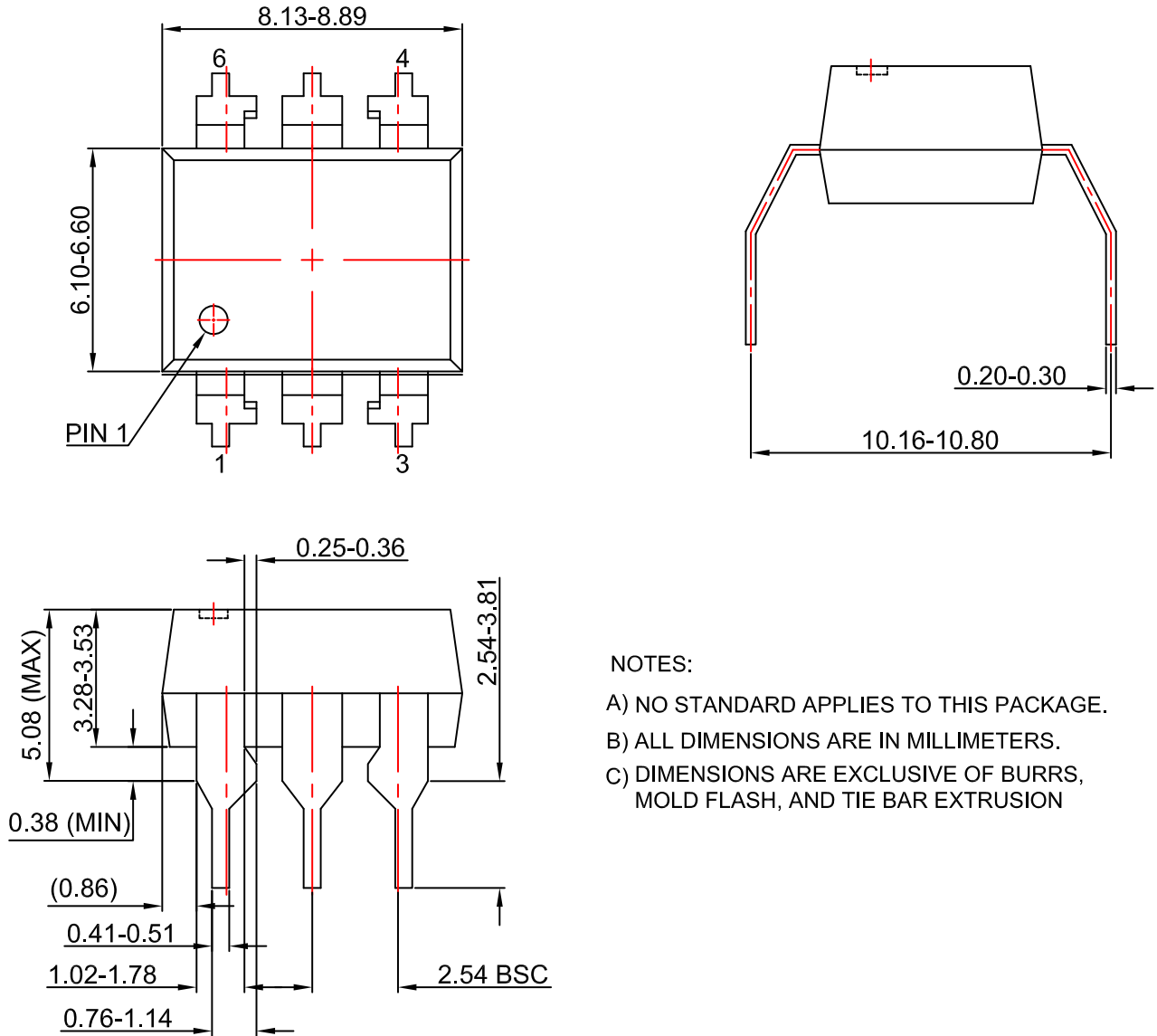

**NOTES:**

- A) NO STANDARD APPLIES TO THIS PACKAGE.
- B) ALL DIMENSIONS ARE IN MILLIMETERS.
- C) DIMENSIONS ARE EXCLUSIVE OF BURRS, MOLD FLASH, AND TIE BAR EXTRUSION

<b>DOCUMENT NUMBER:</b>	<b>98AON13451G</b>	Electronic versions are uncontrolled except when accessed directly from the Document Repository. Printed versions are uncontrolled except when stamped "CONTROLLED COPY" in red.
<b>DESCRIPTION:</b>	<b>PDIP6 8.51X6.35, 2.54P</b>	<b>PAGE 1 OF 1</b>

ON Semiconductor and are trademarks of Semiconductor Components Industries, LLC dba ON Semiconductor or its subsidiaries in the United States and/or other countries. ON Semiconductor reserves the right to make changes without further notice to any products herein. ON Semiconductor makes no warranty, representation or guarantee regarding the suitability of its products for any particular purpose, nor does ON Semiconductor assume any liability arising out of the application or use of any product or circuit, and specifically disclaims any and all liability, including without limitation special, consequential or incidental damages. ON Semiconductor does not convey any license under its patent rights nor the rights of others.

**onsemi**, **Onsemi**, and other names, marks, and brands are registered and/or common law trademarks of Semiconductor Components Industries, LLC dba "**onsemi**" or its affiliates and/or subsidiaries in the United States and/or other countries. **onsemi** owns the rights to a number of patents, trademarks, copyrights, trade secrets, and other intellectual property. A listing of **onsemi**'s product/patent coverage may be accessed at [www.onsemi.com/site/pdf/Patent-Marking.pdf](http://www.onsemi.com/site/pdf/Patent-Marking.pdf). **onsemi** reserves the right to make changes at any time to any products or information herein, without notice. The information herein is provided "as-is" and **onsemi** makes no warranty, representation or guarantee regarding the accuracy of the information, product features, availability, functionality, or suitability of its products for any particular purpose, nor does **onsemi** assume any liability arising out of the application or use of any product or circuit, and specifically disclaims any and all liability, including without limitation special, consequential or incidental damages. Buyer is responsible for its products and applications using **onsemi** products, including compliance with all laws, regulations and safety requirements or standards, regardless of any support or applications information provided by **onsemi**. "Typical" parameters which may be provided in **onsemi** data sheets and/or specifications can and do vary in different applications and actual performance may vary over time. All operating parameters, including "Typicals" must be validated for each customer application by customer's technical experts. **onsemi** does not convey any license under any of its intellectual property rights nor the rights of others. **onsemi** products are not designed, intended, or authorized for use as a critical component in life support systems or any FDA Class 3 medical devices or medical devices with a same or similar classification in a foreign jurisdiction or any devices intended for implantation in the human body. Should Buyer purchase or use **onsemi** products for any such unintended or unauthorized application, Buyer shall indemnify and hold **onsemi** and its officers, employees, subsidiaries, affiliates, and distributors harmless against all claims, costs, damages, and expenses, and reasonable attorney fees arising out of, directly or indirectly, any claim of personal injury or death associated with such unintended or unauthorized use, even if such claim alleges that **onsemi** was negligent regarding the design or manufacture of the part. **onsemi** is an Equal Opportunity/Affirmative Action Employer. This literature is subject to all applicable copyright laws and is not for resale in any manner.

## PUBLICATION ORDERING INFORMATION

### LITERATURE FULFILLMENT:

Email Requests to: [orderlit@onsemi.com](mailto:orderlit@onsemi.com)

**onsemi Website:** [www.onsemi.com](http://www.onsemi.com)

### TECHNICAL SUPPORT

**North American Technical Support:**  
Voice Mail: 1 800-282-9855 Toll Free USA/Canada  
Phone: 011 421 33 790 2910

**Europe, Middle East and Africa Technical Support:**

Phone: 00421 33 790 2910

For additional information, please contact your local Sales Representative

# Mouser Electronics

Authorized Distributor

Click to View Pricing, Inventory, Delivery & Lifecycle Information:

[onsemi:](#)

[4N33M](#) [4N32M](#) [4N32SR2M](#) [4N33SM](#) [4N33VM](#) [4N29M](#) [4N30SM](#) [4N29SR2M](#) [4N30M](#) [4N32VM](#) [H11B1SM](#)  
[4N30SR2M](#) [H11B1VM](#) [H11B1M](#) [H11B1SR2M](#) [4N32SM](#) [4N32TVM](#) [4N29SM](#) [H11B1SR2VM](#) [4N33TVM](#) [4N33SR2M](#)